

**Strut materiaal**

roestvaststaal

*Strut material*

*stainless steel*



- chemisch resistent
- kwaliteit AISI 316

- *chemically resistant*
- *Quality AISI 316*

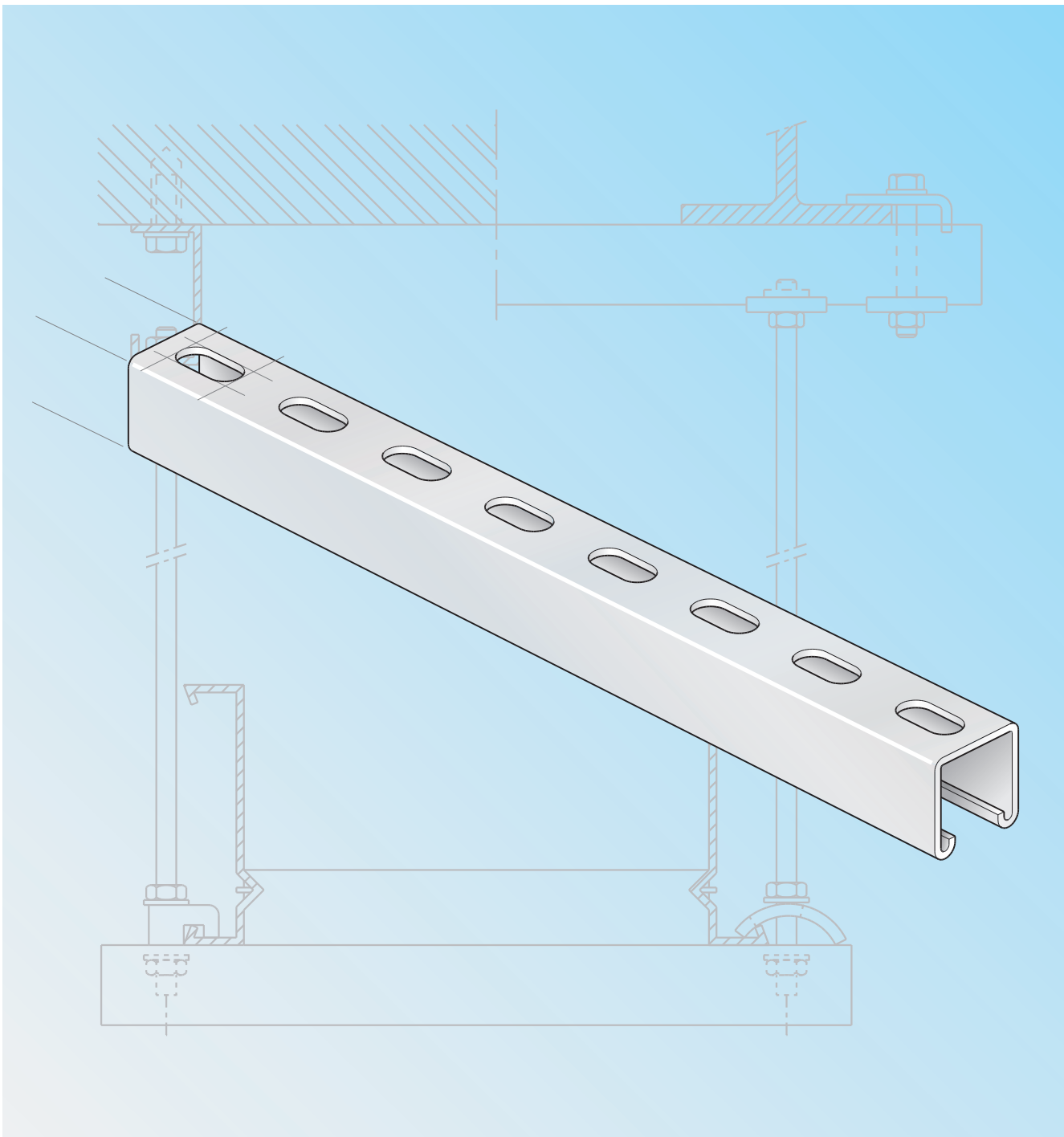

**Montagerail = B21**  
**Hanger channel = B21**

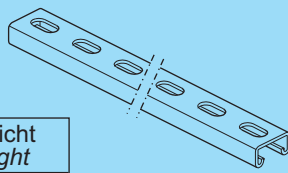

L	Artikel nr. Product no.	Gewicht Weight
3000	98026.206	4,64
6000	98027.206	9,28

**Montagerail = B41**  
**Hanger channel = B41**

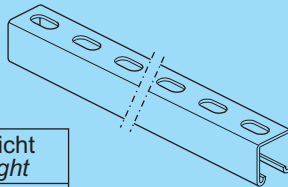

L	Artikel nr. Product no.	Gewicht Weight
3000	98056.206	7,29
6000	98057.206	14,85

**Afdichtstop**  
**Seal cap**

Type	Artikel nr. Product no.	Gewicht Weight
B=21	99961.207	0,01
B=41	99963.207	0,01

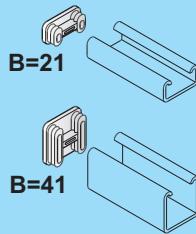

PVC  
zwart / black

**Moerplaat**  
**Nut plate**

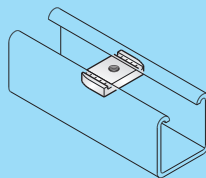
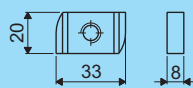

Type	Artikel nr. Product no.	Gewicht Weight
M6	98086.206	0,03
M8	98088.206	0,03
M10	98090.206	0,04

**Montagestrip / Railplaat**  
**Mounting strip / Rail plate**

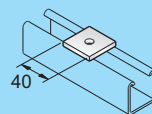

Type	Artikel nr. Product no.	Gewicht Weight
MP-1	98078.206	0,05

MP-1

**Montagestrip - 2 gaten**  
**Mounting strip - 2 holes**

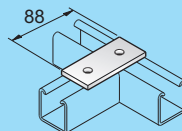

Type	Artikel nr. Product no.	Gewicht Weight
MP-2	98101.206	0,12

MP-2

**Montagestrip - 3 gaten**  
**Mounting strip - 3 holes**

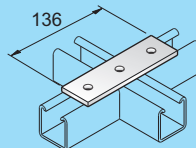

Type	Artikel nr. Product no.	Gewicht Weight
MP-3	98103.206	0,19

MP-3

**Montagestrip - 4 gaten**  
**Mounting strip - 4 holes**

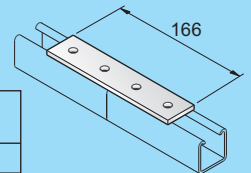

Type	Artikel nr. Product no.	Gewicht Weight
MP-4	98105.206	0,25

MP-4

**T-stuk - 1**  
**T-piece - 1**

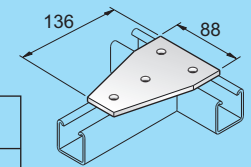

Type	Artikel nr. Product no.	Gewicht Weight
TP-1	98143.206	0,43

TP-1

**T-stuk - 2**  
**T-piece - 2**

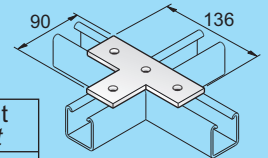

Type	Artikel nr. Product no.	Gewicht Weight
TP-2	98119.206	0,26

TP-2

**Kruisstuk**  
**Cross-piece**

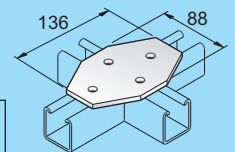

Type	Artikel nr. Product no.	Gewicht Weight
KP-1	98144.206	0,43

KP-1

**Verticaal T-stuk**  
**Vertical T-piece**

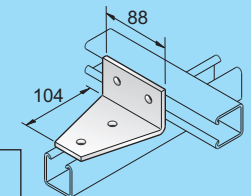

Type	Artikel nr. Product no.	Gewicht Weight
VTP-1	98113.206	0,36

VTP-1

**Verticaal T-stuk**  
**Vertical T-piece**

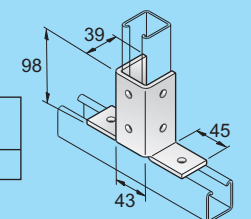

Type	Artikel nr. Product no.	Gewicht Weight
VTP-2	98115.206	0,55

VTP-2

**Hoekstuk vlak 90°**  
**Corner piece flat 90°**

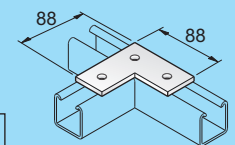

Type	Artikel nr. Product no.	Gewicht Weight
HP-1	98140.206	0,20

HP-1

## Hoekbeugel 90° - 2 gaten Corner brace 90° - 2 holes

Type	Artikel nr. Product no.	Gewicht Weight
VP-2	98111.206	0,12

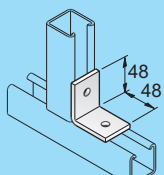

VP-2

## Hoekbeugel 90° - 3 gaten Corner brace 90° - 3 holes

Type	Artikel nr. Product no.	Gewicht Weight
VP-3	98112.206	0,19

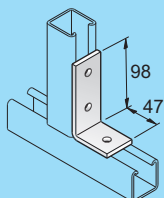

VP-3

## Hoekbeugel 90° - 4 gaten Corner brace 90° - 4 holes

Type	Artikel nr. Product no.	Gewicht Weight
VP-4	98116.206	0,26

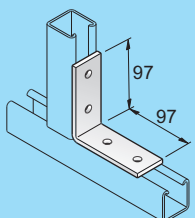

VP-4

## Hoekbeugel buiten 45° Corner brace outer 45°

Type	Artikel nr. Product no.	Gewicht Weight
VP-5	98109.206	0,24

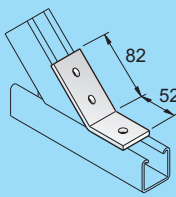

VP-5

## Hoekbeugel binnen 45° Corner brace inner 45°

Type	Artikel nr. Product no.	Gewicht Weight
VP-6	98142.206	0,22

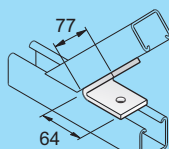

VP-6

## Klembeugel dubbel B21 Clamp brace double B21

Type	Artikel nr. Product no.	Gewicht Weight
KBD-21	98133.206	0,23

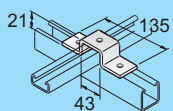

KBD-21

## Klembeugel dubbel B41 Clamp brace double B41

Type	Artikel nr. Product no.	Gewicht Weight
KBD-41	98134.206	0,27

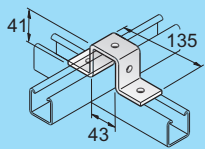

KBD-41

## Klembeugel enkel B21 Clamp brace single B21

Type	Artikel nr. Product no.	Gewicht Weight
KBE-21	98131.206	0,14

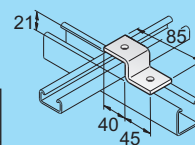

KBE-21

## Klembeugel enkel B41 Clamp brace single B41

Type	Artikel nr. Product no.	Gewicht Weight
KBE-41	98132.206	0,17

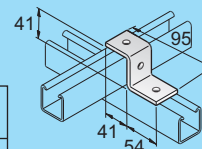

KBE-41

## Vloerbeugel Floor brace

Type	Artikel nr. Product no.	Gewicht Weight
VB-1	98120.206	0,51

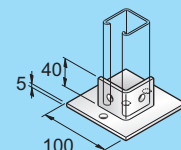

VB-1

## Spanklauw-A Beam clamp-A

Type	Artikel nr. Product no.	Gewicht Weight
SK-A	98548.206	0,09

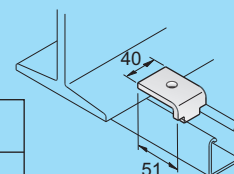

SK-A

## Spanklauw-B Beam clamp-B

Type	Artikel nr. Product no.	Gewicht Weight
SK-B	98546.206	0,08

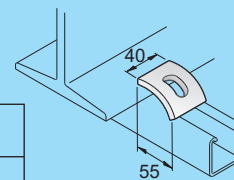

SK-B

## Spanklauw-C Beam clamp-C

Type	Artikel nr. Product no.	Gewicht Weight
SK-C	98550.206	0,09

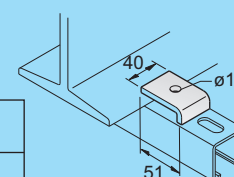

SK-C

## Draagbalkklem Beam clamp

L	Artikel nr. Product no.	Gewicht Weight
21-41	98961.206	0,36
62-83	98963.206	0,40

